

MBN500H65E2

Silicon N-channel IGBT 6500V E2 version

FEATURES

- * Low driving power due to low input capacitance MOS gate.
- * Low noise due to ultra soft fast recovery diode.
- * High reliability, high durability module.
- * High thermal fatigue durability.
($\Delta T_c=70^\circ\text{C}$, $N>30,000$ cycles)
- * Isolated head sink (terminal to base).

ABSOLUTE MAXIMUM RATINGS ($T_c=25^\circ\text{C}$)

Item	Symbol	Unit	MBN500H65E2
Collector Emitter Voltage	V_{CES}	V	$T_j=125^\circ\text{C}$ 6,500
			$T_j=25^\circ\text{C}$ 6,500
			$T_j=-40^\circ\text{C}$ 6,000
Gate Emitter Voltage	V_{GES}	V	± 20
Collector Current	DC	I_C	500 ($T_c=80^\circ\text{C}$)
	1ms	I_{Cp}	1,000
Forward Current	DC	I_F	500
	1ms	I_{FM}	1,000
Junction Temperature	T_j	$^\circ\text{C}$	-40 ~ +125
Storage Temperature	T_{stg}	$^\circ\text{C}$	-50 ~ +125
Isolation Voltage	V_{ISO}	V_{RMS}	10,200 (AC 1 minute)
Screw Torque	Terminals (M4/M8)	-	2/10 (1)
	Mounting (M6)	-	6 (2)

Notes: (1) Recommended Value $1.8\pm 0.2/9\pm 1\text{N}\cdot\text{m}$

(2) Recommended Value $5.5\pm 0.5\text{N}\cdot\text{m}$

ELECTRICAL CHARACTERISTICS

Item	Symbol	Unit	Min.	Typ.	Max.	Test Conditions
Collector Emitter Cut-Off Current	I_{CES}	mA	-	-	17	$V_{CE}=6,500\text{V}$, $V_{GE}=0\text{V}$, $T_j=25^\circ\text{C}$
			-	17	67	$V_{CE}=6,500\text{V}$, $V_{GE}=0\text{V}$, $T_j=125^\circ\text{C}$
Gate Emitter Leakage Current	I_{GES}	nA	-500	-	+500	$V_{GE}=\pm 20\text{V}$, $V_{CE}=0\text{V}$, $T_j=25^\circ\text{C}$
Collector Emitter Saturation Voltage	$V_{CE(sat)}$	V	-	3.2	-	$I_C=500\text{A}$, $V_{GE}=15\text{V}$, $T_j=25^\circ\text{C}$
			3.4	4.3	5.2	$I_C=500\text{A}$, $V_{GE}=15\text{V}$, $T_j=125^\circ\text{C}$
Gate Emitter Threshold Voltage	$V_{GE(TO)}$	V	5.8	6.3	6.8	$V_{CE}=10\text{V}$, $I_C=500\text{mA}$, $T_j=25^\circ\text{C}$
Input Capacitance	C_{ies}	nF	-	87	-	$V_{CE}=10\text{V}$, $V_{GE}=0\text{V}$, $f=100\text{kHz}$, $T_j=25^\circ\text{C}$
Internal Gate Resistance	R_{ge}	Ω	-	1.1	-	$V_{CE}=10\text{V}$, $V_{GE}=0\text{V}$, $f=100\text{kHz}$, $T_j=25^\circ\text{C}$
Switching Times	Rise Time	t_r	2.2	3.2	4.8	$V_{CC}=3,600\text{V}$, $I_C=500\text{A}$
	Turn On Time	t_{on}	2.7	3.9	5.9	$L_s=210\text{nH}$
	Fall Time	t_f	2.2	3.1	4.7	$R_G=12\Omega$ (3)
	Turn Off Time	t_{off}	4.5	6.4	9.6	$V_{GE}=\pm 15\text{V}$, $T_j=125^\circ\text{C}$
Peak Forward Voltage Drop	V_{FM}	V	-	3.6	-	$I_F=500\text{A}$, $V_{GE}=0\text{V}$, $T_j=25^\circ\text{C}$
			3.5	3.9	4.4	$I_F=500\text{A}$, $V_{GE}=0\text{V}$, $T_j=125^\circ\text{C}$
Reverse Recovery Time	t_{rr}	μs	-	0.8	1.6	$V_{CC}=3,600\text{V}$, $I_F=500\text{A}$, $L_s=210\text{nH}$ $T_j=125^\circ\text{C}$
Turn On Loss	$E_{on(10\%)}$	J/p	-	3.3	4.3	$V_{CC}=3600\text{V}$, $I_C= I_F=500\text{A}$, $L_s=210\text{nH}$ $R_G=12\Omega$ (3) $V_{GE}=\pm 15\text{V}$, $T_j=125^\circ\text{C}$
	$E_{on(full)}$		-	3.7	-	
Turn Off Loss	$E_{off(10\%)}$	J/p	-	2.6	3.4	
	$E_{off(full)}$		-	2.8	-	
Reverse Recovery Loss	$E_{rr(10\%)}$	J/p	-	1.4	1.8	
	$E_{rr(full)}$		-	1.5	-	

Notes:(3) R_G value is the test condition's value for evaluation of the switching times, not recommended value.

Please, determine the suitable R_G value after the measurement of switching waveforms (overshoot voltage, etc.) with appliance mounted.

* Please contact our representatives at order.

* For improvement, specifications are subject to change without notice.

* For actual application, please confirm this spec sheet is the newest revision.

MBN500H65E2

THERMAL CHARACTERISTICS

Item		Symbol	Unit	Min.	Typ.	Max.	Conditions
Thermal Impedance	IGBT	Rth(j-c)	K/W	-	-	0.0135	Junction to case
	FWD	Rth(j-c)		-	-	0.027	
Contact Thermal Impedance		Rth(c-f)	K/W	-	0.007	-	Case to fin ($\lambda_{grease}=1W/(m \cdot K)$, heat-sink flatness $\leq 50\mu m$)

MODULE MECHANICAL CHARACTERISTICS

Item		Unit	Characteristics	Conditions
Weight		g	1,050	
Stray inductance in module	LS(CM-EM)	nH	21	Collector-main to Emitter-main
Comparative Tracking Index	(CTI)		600	
Module base plate Material			Al-SiC	
Baseplate Thickness		mm	5	
Insulation plate Material			Al N	
Terminal Surface treatment			Ni plating	
Case Material			Poly-Phenilene Sulfide	
Fire and Smoke Category			I2 / F3	NFF 16-102

MBN500H65E2

DEFINITION OF TEST CIRCUIT

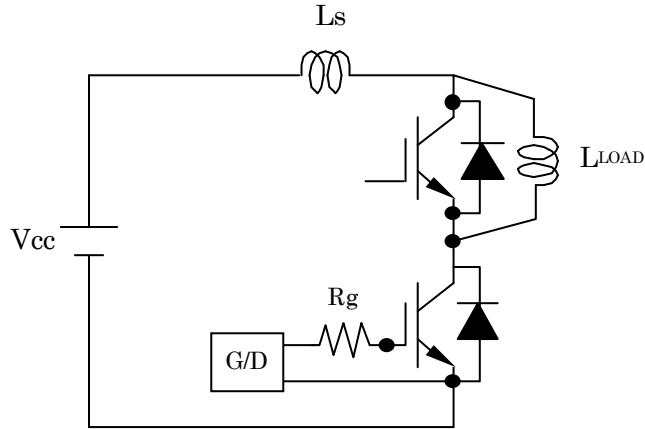

Fig.1 Switching test circuit

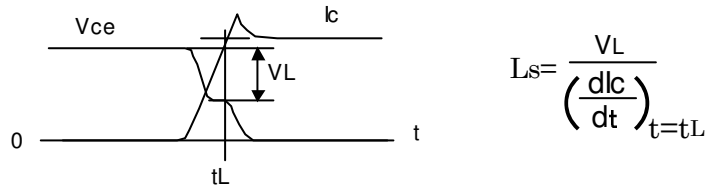

Fig.2 Definition of Ls

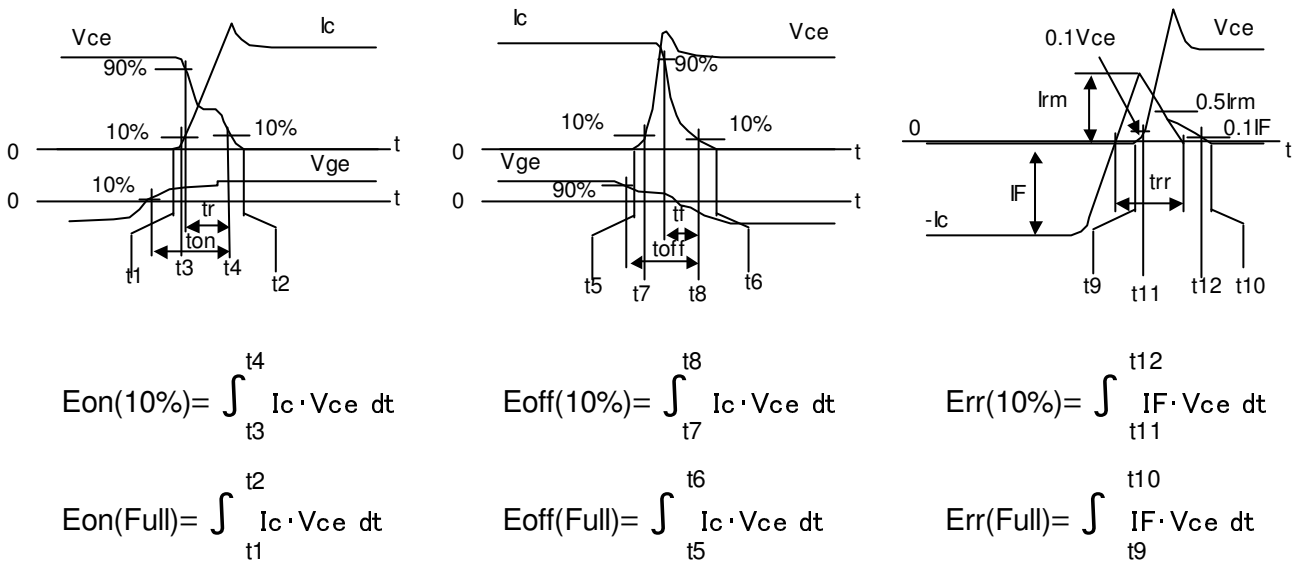
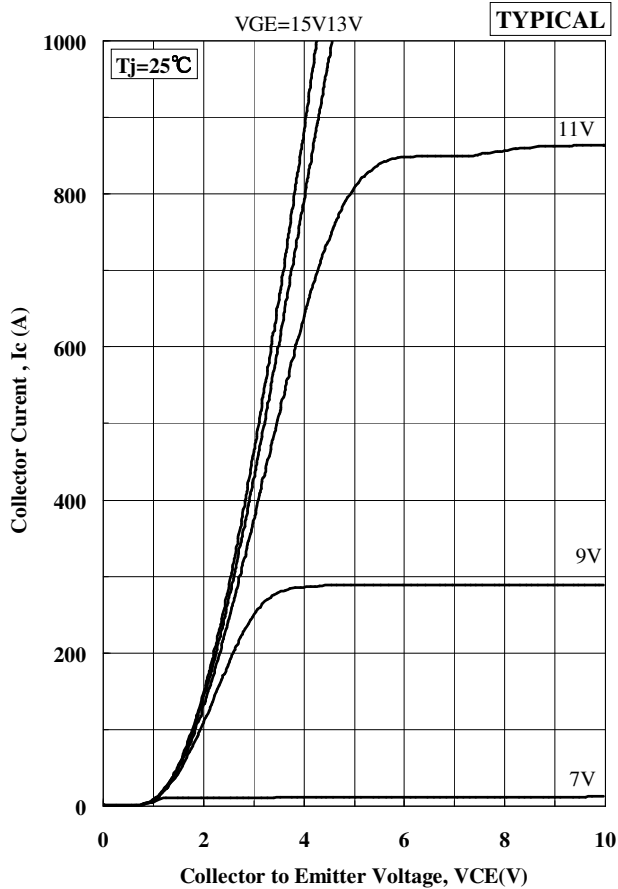

Fig.3 Definition of switching loss

MBN500H65E2

CHARACTERISTICS CURVE

STATIC CHARACTERISTICS



Collector Current vs. Collector to Emitter Voltage

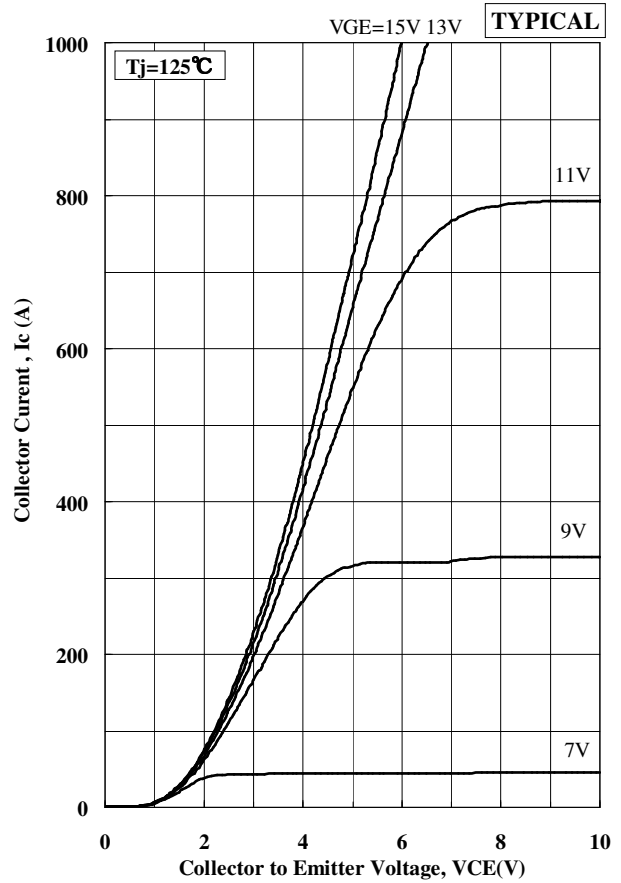

Collector Current vs. Collector to Emitter Voltage

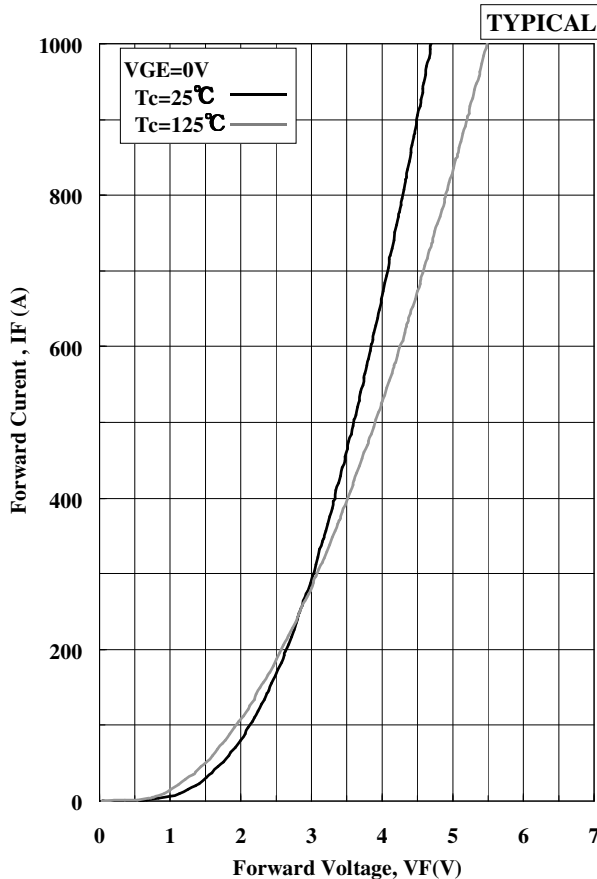

Forward Voltage of free-wheeling diode

MBN500H65E2

DYNAMIC CHARACTERISTICS

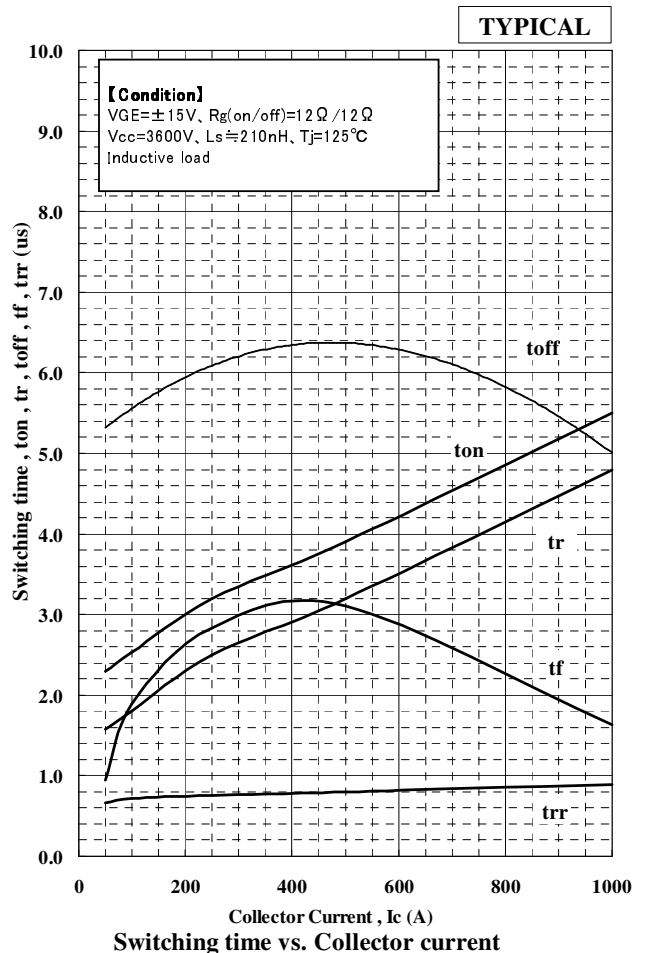
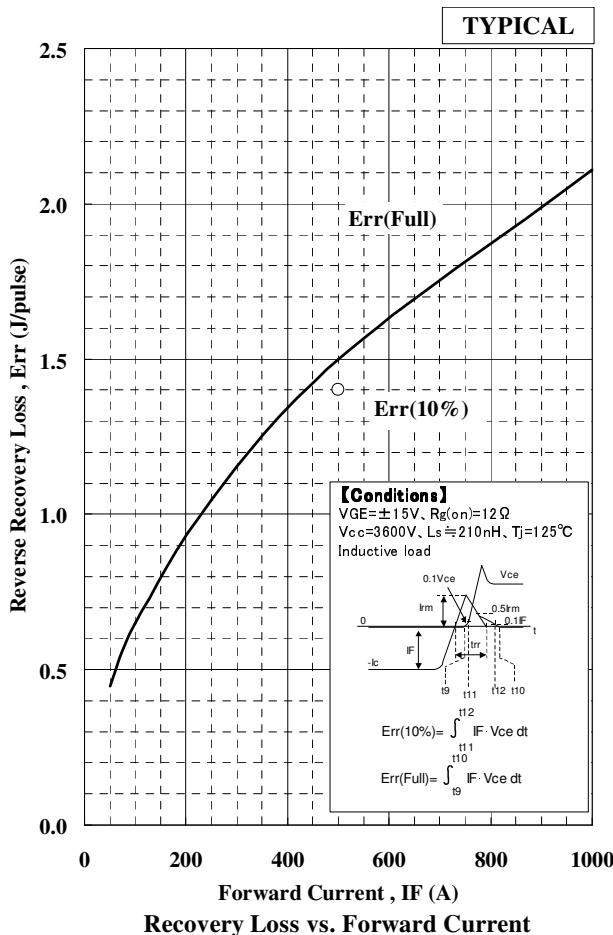
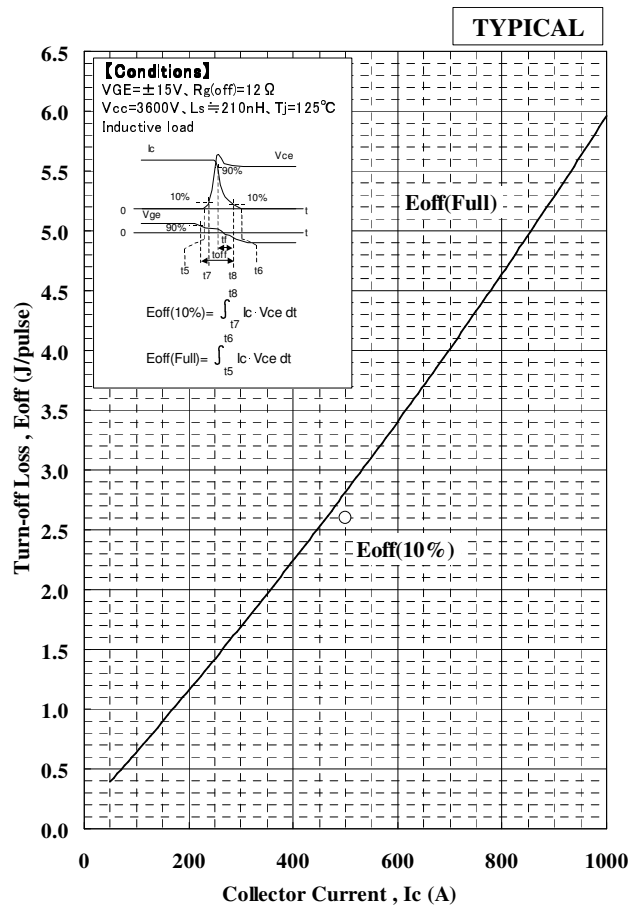
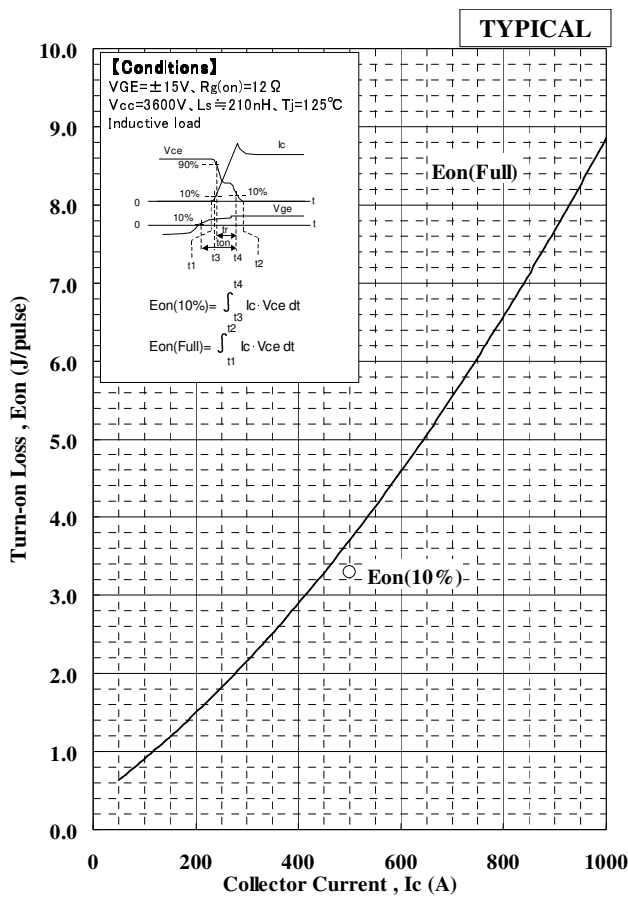

MBN500H65E2

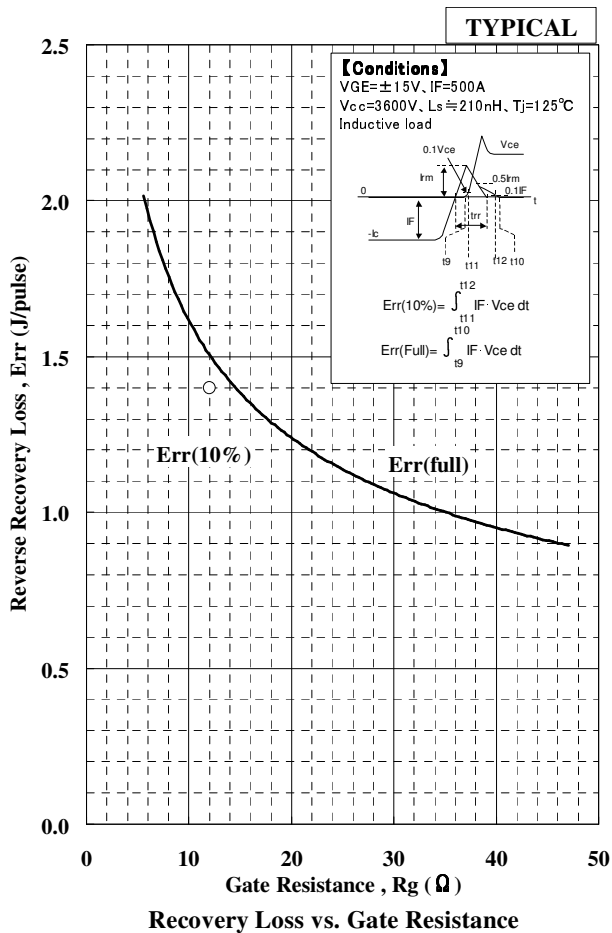
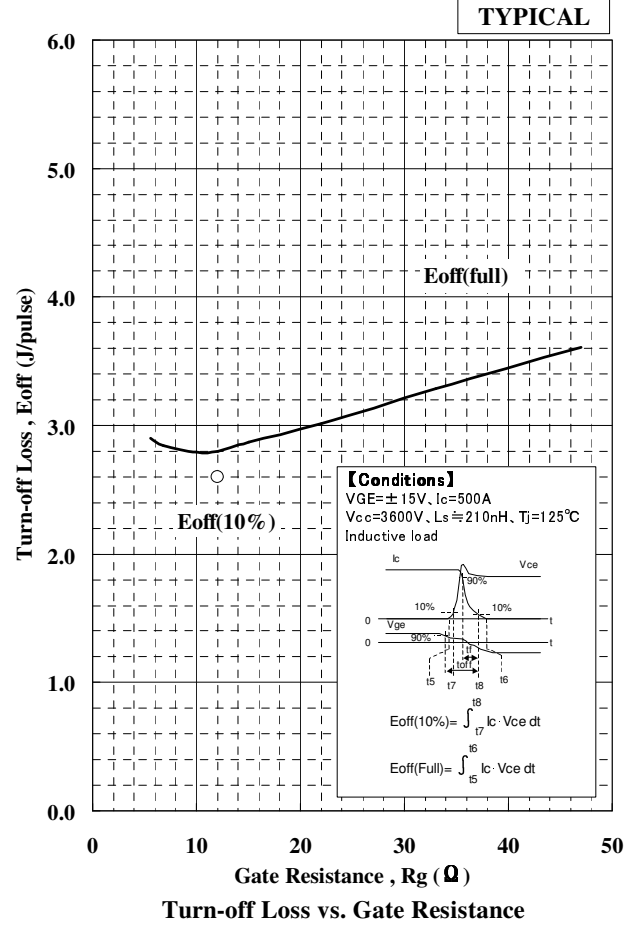
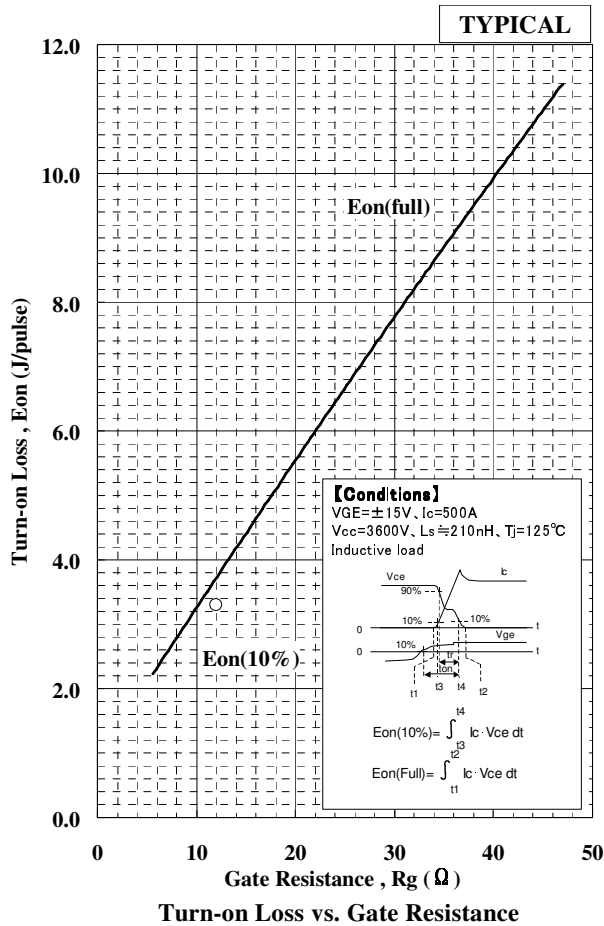

MBN500H65E2

PACKAGE OUTLINE DRAWING

Unit: mm

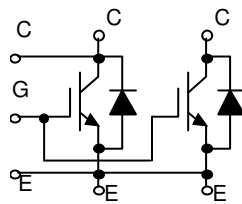
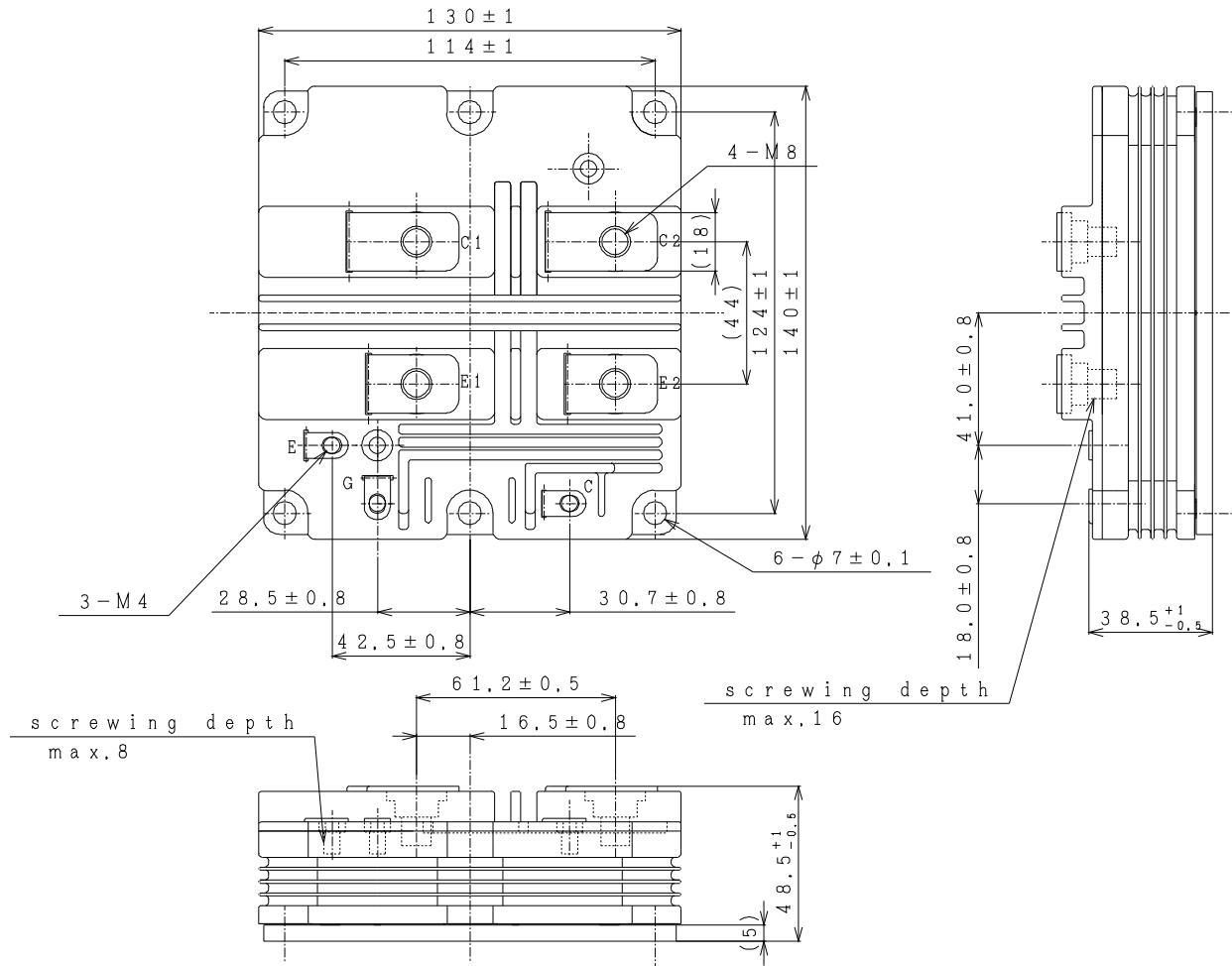

Circuit diagram

MBN500H65E2

TRANSIENT THERMAL IMPEDANCE

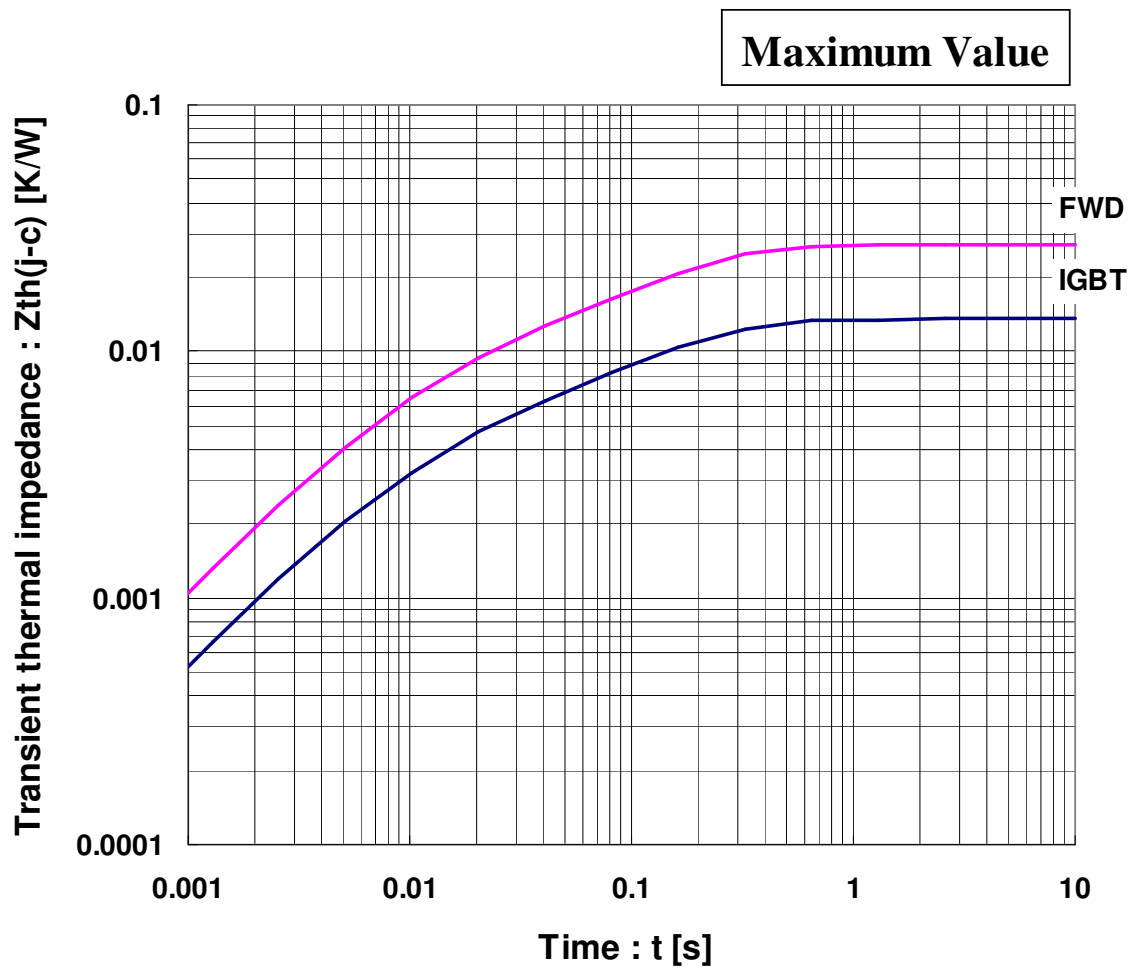

Transient Thermal Impedance Curve

MBN500H65E2

RBSOA

Conditions: $L_s \leq 210\text{nH}$, $V_{cc} \leq 4400\text{V}$,
 $I_c \leq 1000\text{A}$, $V_{GE} = \pm 15\text{V}$,
 $R_{g(\text{on/off})} \geq 12/12\Omega$, $-40^\circ\text{C} \leq T_c \leq 125^\circ\text{C}$
 on pulse width $\geq 20\mu\text{s}$
 (V_{ce} spike voltage and L_s are defined
 at auxiliary terminal)

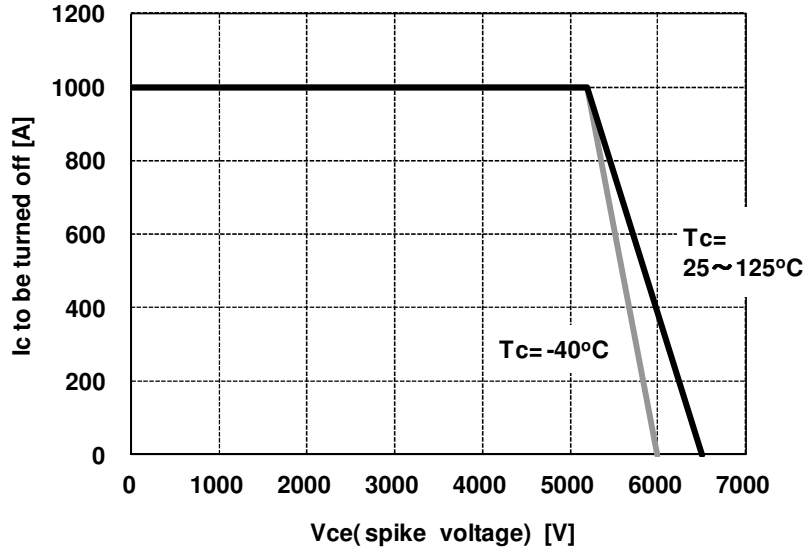
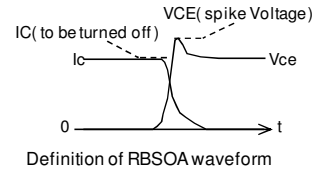

Reverse bias safe operation area (RBSOA)

Recovery SOA

Conditions:
 $L_s \leq 210\text{nH}$, $V_{cc} \leq 4400\text{V}$, $-I_c \leq 1000\text{A}$, $V_{GE} = -15\text{V}$,
 $R_{g(\text{on})}$ of across IGBT $\geq 12\Omega$, V_{GE} of across IGBT $= \pm 15\text{V}$,
 $-40^\circ\text{C} \leq T_c \leq 125^\circ\text{C}$, V_{AK} defined at auxiliary terminal
 Conduction pulse width of diode $\geq 30\mu\text{s}$

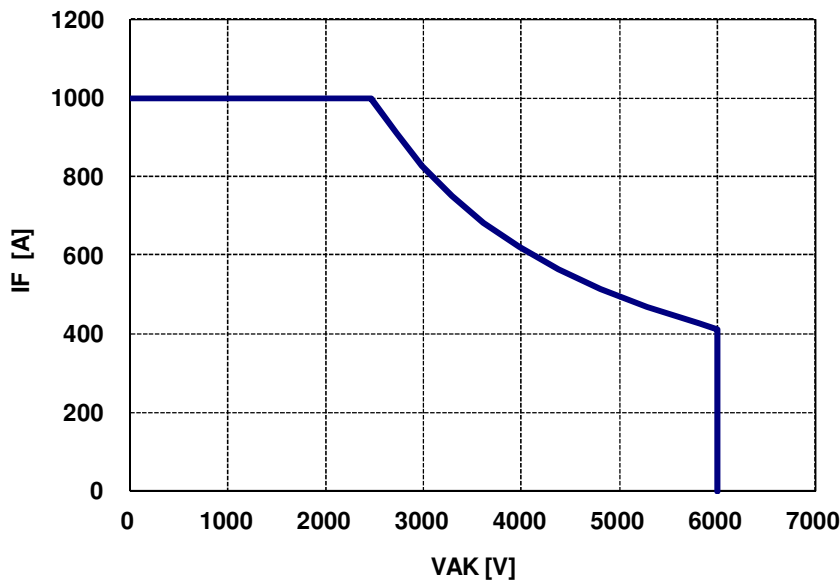

RecSOA

MBN500H65E2

QG-VGE Curve

TYPICAL

Conditions: $L_s=300\text{nH}$, $V_{CC}=3600\text{V}$, $V_{GE}=\pm 15\text{V}$,
 $R_{G(\text{on/off})}=68\Omega/12\Omega$, $T_j=25^\circ\text{C}$,

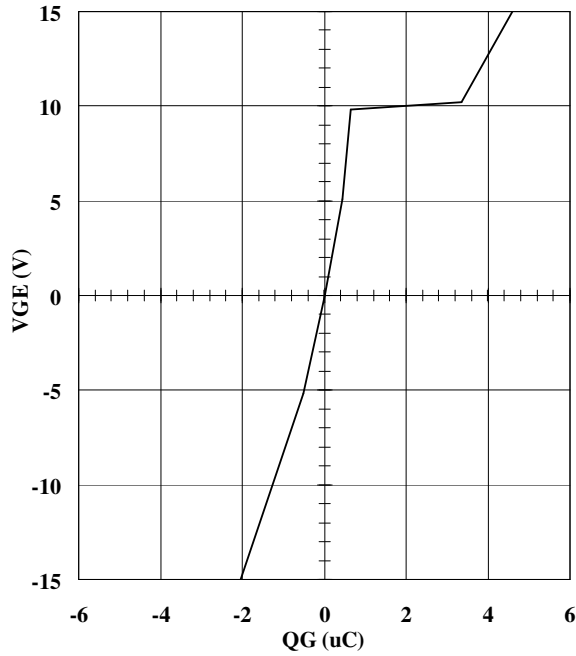

QG-VGE curve

Material declaration

Please note the following materials are contained in the product, in order to keep characteristic and reliability level.

Material	Contained part
Lead (Pb) and its compounds	Solder

MBN500H65E2

HITACHI POWER SEMICONDUCTORS

Notices

1. The information given herein, including the specifications and dimensions, is subject to change without prior notice to improve product characteristics. Before ordering, purchasers are advised to contact Hitachi sales department for the latest version of this data sheets.
2. Please be sure to read "Precautions for Safe Use and Notices" in the individual brochure before use.
3. In cases where extremely high reliability is required (such as use in nuclear power control, aerospace and aviation, traffic equipment, life-support-related medical equipment, fuel control equipment and various kinds of safety equipment), safety should be ensured by using semiconductor devices that feature assured safety or by means of users' fail-safe precautions or other arrangement. Or consult Hitachi's sales department staff.
4. In no event shall Hitachi be liable for any damages that may result from an accident or any other cause during operation of the user's units according to this data sheets. Hitachi assumes no responsibility for any intellectual property claims or any other problems that may result from applications of information, products or circuits described in this data sheets.
5. In no event shall Hitachi be liable for any failure in a semiconductor device or any secondary damage resulting from use at a value exceeding the absolute maximum rating.
6. No license is granted by this data sheets under any patents or other rights of any third party or Hitachi Power Semiconductor Device, Ltd.
7. This data sheets may not be reproduced or duplicated, in any form, in whole or in part, without the expressed written permission of Hitachi Power Semiconductor Device, Ltd.
8. The products (technologies) described in this data sheets are not to be provided to any party whose purpose in their application will hinder maintenance of international peace and safety not are they to be applied to that purpose by their direct purchasers or any third party. When exporting these products (technologies), the necessary procedures are to be taken in accordance with related laws and regulations.

-
- For inquiries relating to the products, please contact nearest overseas representatives that is located "Inquiry" portion on the top page of a home page.
-

Hitachi power semiconductor home page address <http://www.hitachi-power-semiconductor-device.co.jp/en/>