

MBN1800E17E

Silicon N-channel IGBT

1. FEATURES

- * Low noise, low loss IGBT module due to soft-LiPT Trench Technology
- * Low noise due to ultra soft fast recovery diode. (U-SFD)
- * High reverse recovery capability (HiRC)
- * High thermal fatigue durability. ($\Delta T_c=70K$, $N>30,000$ cycles)

2. ABSOLUTE MAXIMUM RATINGS ($T_c=25^\circ C$)

Item	Symbol	Unit	MBN1800E17E	
Collector Emitter Voltage	V_{CES}	V	1,700	
Gate Emitter Voltage	V_{GES}	V	± 20	
Collector Current	DC	I_C	1,800	
	1ms	I_{CP}	3,600	
Forward Current	DC	I_F	1,800	
	1ms	I_{FM}	3,600	
Total Power dissipation	P_{tot}	kW	8.3	
Junction Temperature	T_j	$^\circ C$	-40 ~ +125	
Storage Temperature	T_{stg}	$^\circ C$	-40 ~ +125	
Isolation Voltage	V_{ISO}	V_{RMS}	4,000 (AC 1 minute)	
Screw Torque	Terminals	(M4)	-	2 ⁽¹⁾
		(M8)	-	15 ⁽¹⁾
	Mounting	(M6)	-	5 ⁽²⁾

Notes: (1) Recommended Value $2.0^{+0.1}_{-0.2} / 15^{+0}_{-3} N \cdot m$
 (2) Recommended Value $5.0 \pm 1 N \cdot m$

* Please contact our representatives at order.

* For improvement, specifications are subject to change without notice.

* For actual application, please confirm this spec sheet is the newest revision.

MBN1800E17E

3. ELECTRIC CHARACTERISTICS

Item	Symbol	Unit	Min.	Typ.	Max.	Test Conditions
Collector Emitter Cut-Off Current	I_{CES}	mA	-	-	10	$V_{CE}=1,700V, V_{GE}=0V, T_j=25^\circ C$
			-	15	50	$V_{CE}=1,700V, V_{GE}=0V, T_j=125^\circ C$
Gate Emitter Leakage Current	I_{GES}	nA	-500	-	+500	$V_{GE}=\pm 20V, V_{CE}=0V, T_j=25^\circ C$
Collector Emitter Saturation Voltage	$V_{CE(sat)}$	V	-	2.0	-	$I_C=1,800A, V_{GE}=15V, T_j=25^\circ C$
			1.7	2.2	2.8	$I_C=1,800A, V_{GE}=15V, T_j=125^\circ C$
Gate Emitter Threshold Voltage	$V_{GE(TO)}$	V	5.0	6.5	8.0	$V_{CE}=10V, I_C=180mA, T_j=25^\circ C$
Input Capacitance	C_{ies}	nF	-	150	-	$V_{CE}=10V, V_{GE}=0V$
Reverse transfer Capacitance	C_{res}	nF	-	9	-	
Output Capacitance	C_{oes}	nF	-	17	-	$f=100kHz, T_j=25^\circ C$
Total Gate Charge	Q_G	μC	-	11	-	$V_{GE}=\pm 15V, V_{CC}=900V, I_C=1,800A$
Turn-on Gate Charge	QG(on)	μC	-	5.0	-	$V_{GE}=-15V \rightarrow 0V, V_{CC}=900V, I_C=1,800A$
			-	6.5	-	$V_{GE}=-15V \rightarrow 8V, V_{CC}=900V, I_C=1,800A$
Internal Gate Resistance (Tentative)	$R_{ge(int)}$	Ω	0.9	1.4	2.1	$V_{CE}=10V, V_{GE}=0V, f=100kHz, T_j=25^\circ C$
Switching Times	Turn on delay Time	$t_{d(on)}$	0.5	1.1	2.2	$V_{CC}=900V, I_C=1,800A$
	Rise Time	t_r	0.5	1.1	2.2	
	Turn On Time	t_{on}	1.0	2.2	4.4	$L=100nH$
	Turn off delay Time	$t_{d(off)}$	0.6	1.3	2.6	$R_G(on/off)=6.8/2.7\Omega^{(3)}$
	Fall Time	t_f	0.3	0.9	1.8	
	Turn Off Time	t_{off}	1.0	2.2	4.4	$V_{GE}=\pm 15V, T_j=125^\circ C$
Peak Forward Voltage Drop	V_{FM}	V	-	1.8	-	$I_F=1,800A, V_{GE}=0V, T_j=25^\circ C$
			1.4	1.9	2.5	$I_F=1,800A, V_{GE}=0V, T_j=125^\circ C$
Reverse Recovery Time	t_{rr}	μs	0.2	0.7	1.4	$V_{CC}=900V, I_C=1,800A$ $L=100nH$ $R_G(on/off)=6.8/2.7\Omega^{(3)}$ $V_{GE}=\pm 15V, T_j=125^\circ C$
Turn On Loss	$E_{on(10\%)}$	J/P	-	0.45	0.68	
	$E_{on(Full)}$	J/P	-	0.6	(0.9)	
Turn Off Loss	$E_{off(10\%)}$	J/P	-	1.0	1.5	
	$E_{off(Full)}$	J/P	-	1.1	(1.65)	
Reverse Recovery Loss	$E_{rr(10\%)}$	J/P	-	0.6	0.9	
	$E_{rr(Full)}$	J/P	-	0.75	(1.15)	
Reverse Recovery Peak Current	I_{RRM}	A	-	1500	-	
RBSOA	I_C	A	3600	-	-	$V_{CC}=1100V, L=100nH, R_G(on/off)=6.8/2.7\Omega^{(3)}$
Recovery SOA	I_F	A	3600	-	-	$V_{GE}=\pm 15V, T_j=125^\circ C$
I^2t value	I^2t	kA^2s	-	1000	-	$T_{I,start}=125^\circ C, 10ms, V_R=0V$
Partial Discharge Extinction Voltage	V_{PDoff}	V_{RMS}	1.3	-	-	$Q=10pC, 50Hz,$

Notes : (3) R_G value is the test condition's value for evaluation of the switching times, not recommended value.

Please, determine the suitable R_G value after the measurement of switching waveforms (overshoot voltage, etc.) with appliance mounted.

4. THERMAL CHARACTERISTICS

Item	Symbol	Unit	Min.	Typ.	Max.	Test Conditions	
Thermal Resistance	IGBT	$R_{th(j-c)}$	K/W	-	-	0.012	Junction to case
	FWD	$R_{th(j-c)}$		-	-	0.015	
Contact Thermal Impedance	$R_{th(c-f)}$	K/W	-	0.006	-	Case to fin. Thermal grease applied. Thickness 100 μm , Thermal conductivity of grease: 1W/mK	

MBN1800E17E

5. MODULE MECHANICAL CHARACTERISTICS

Item	Unit	Characteristics	Conditions	
Weight	g	1300		
Creeping Distance	Between terminal	mm	49	
	Terminal-Base	mm	33	
Clearance Distance	Between terminal	mm	22	
	Terminal-Base	mm	25	
Stray inductance in module	LS (C M - E M)	nH	12	Collector-main to Emitter-main
	LS (E S - E M)		3.8	Emitter-sense to Emitter-main
	LS (C M - C S)		6.4	Collector-main to Collector sense
Terminal Resistance	R_{Terminal}	m Ω	0.09	Collector-main to Emitter-main
Comparative Tracking Index (CTI)			600	
Module base plate Material			Al-SiC	
Baseplate Thickness	mm		5	
Insulation Material			Al N	
Terminal Surface treatment			Ni plating	
Case Material			Poly-Phenilene Sulfide	
Fire and Smoke Category			I2 / F3	NFF 16-102

6. CIRCUIT DIAGRAM

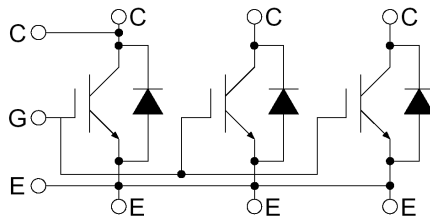

MBN1800E17E

7. CHARACTERISTICS CURVE

7.1 STATIC CHARACTERISTICS

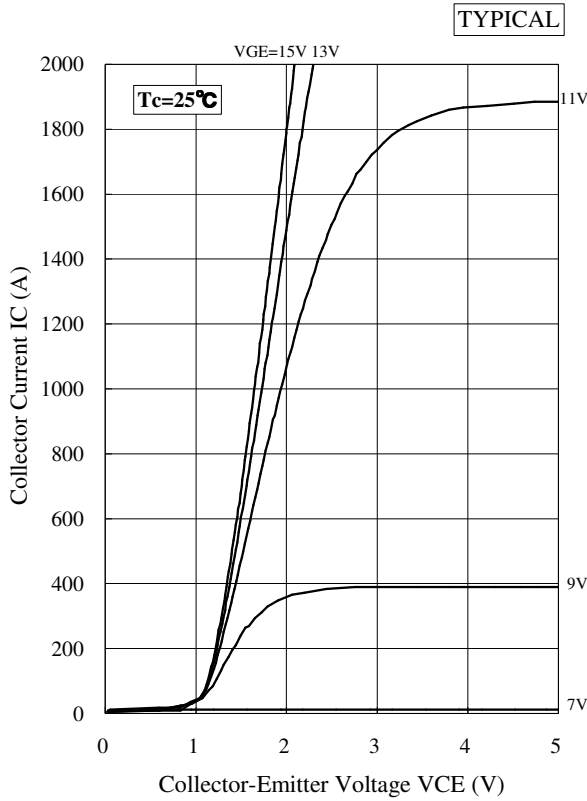

Collector Current vs. Collector to Emittor Voltage

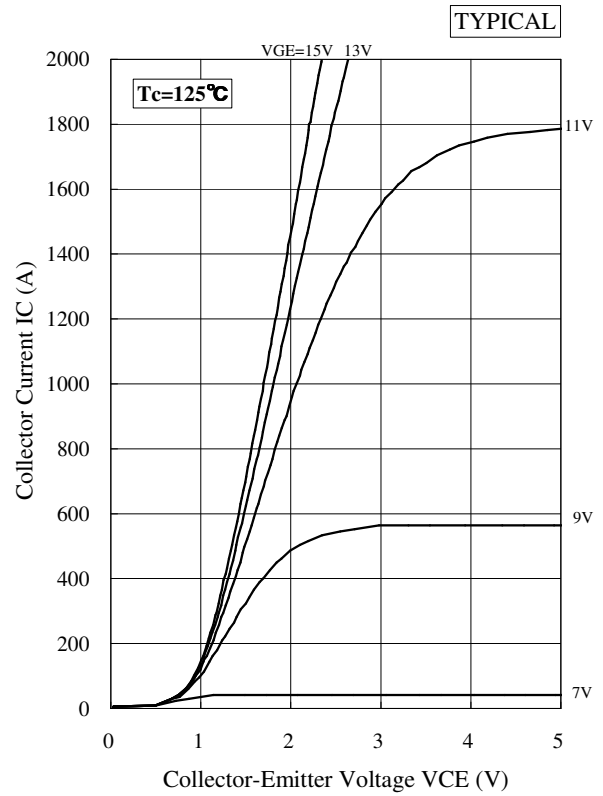

Collector Current vs. Collector to Emittor Voltage

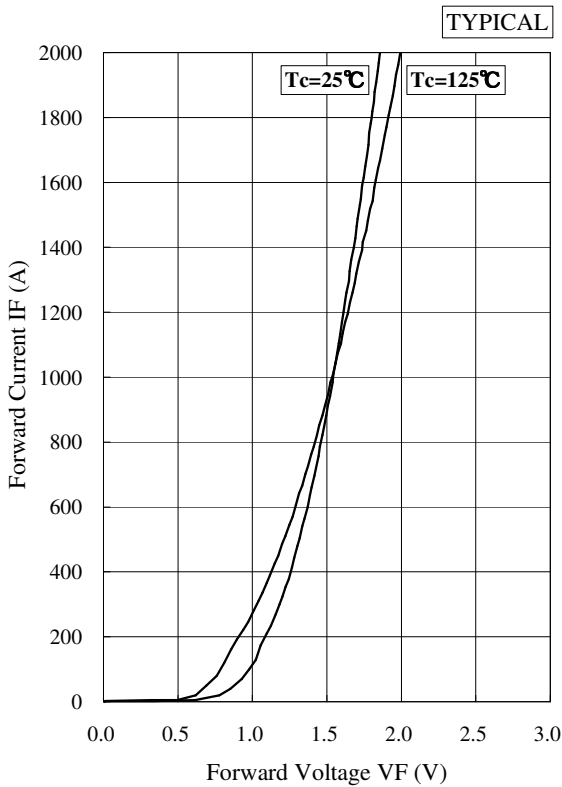

Forward Voltage of free-wheeling diode

MBN1800E17E

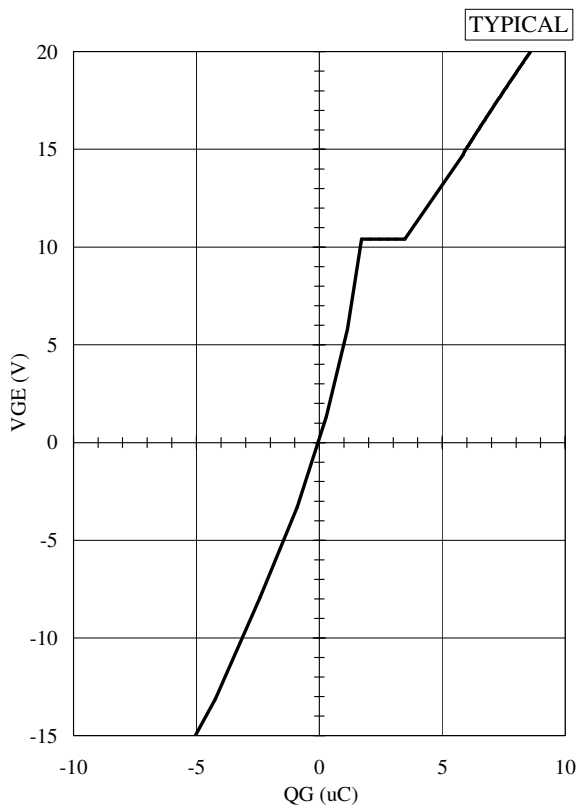

QG-VGE curve

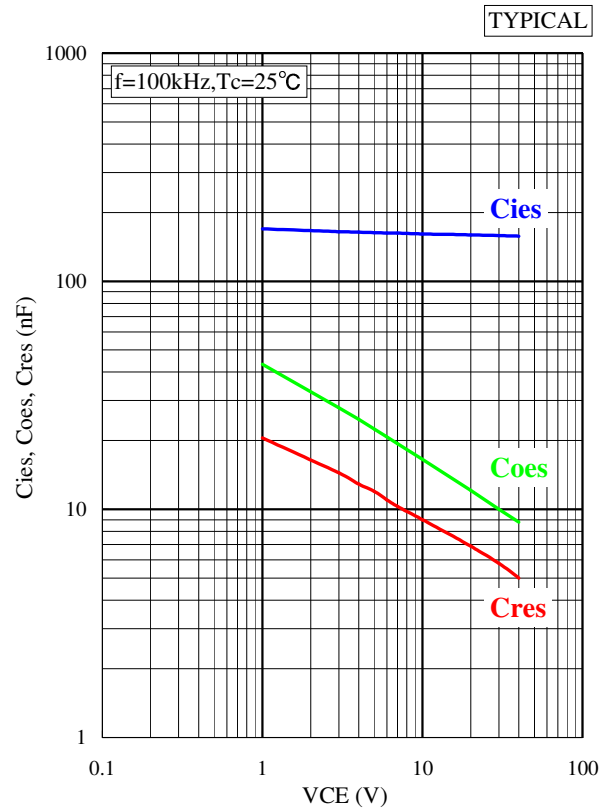

Cies, Coes, Cres vs. Vce

MBN1800E17E

7.2 DYNAMIC CHARACTERISTICS

7.2.1 CIRCUIT

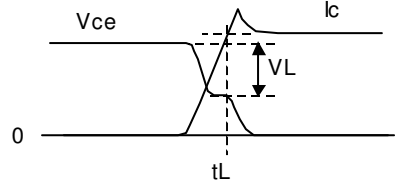
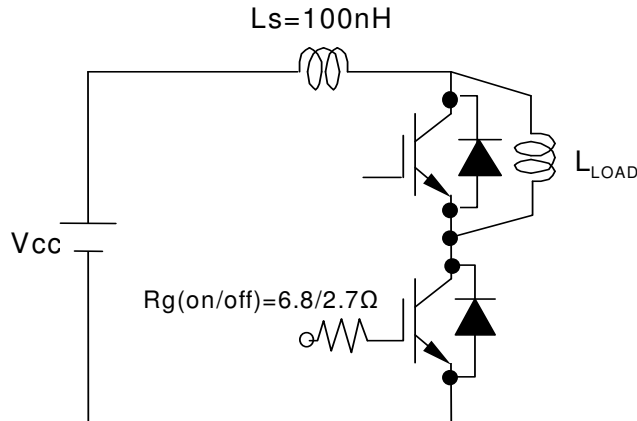

$$L_s = \frac{V_L}{\left(\frac{dI_c}{dt}\right)_{t=t_L}}$$

Definition of L_s

7.2.2 WAVEFORM DEFINITION

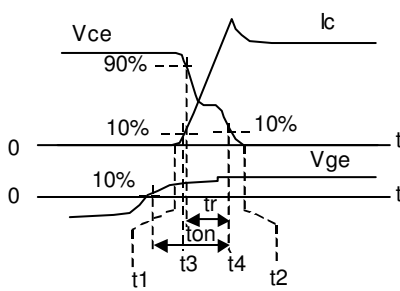

$$E_{on}(10\%) = \int_{t_3}^{t_4} I_c \cdot V_{ce} dt$$

$$E_{on}(Full) = \int_{t_1}^{t_2} I_c \cdot V_{ce} dt$$

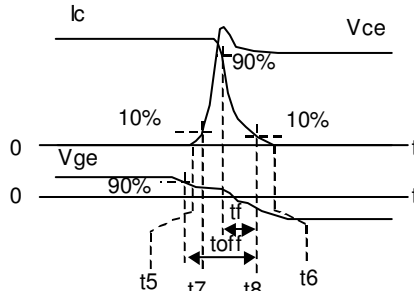

$$E_{off}(10\%) = \int_{t_7}^{t_8} I_c \cdot V_{ce} dt$$

$$E_{off}(Full) = \int_{t_5}^{t_6} I_c \cdot V_{ce} dt$$

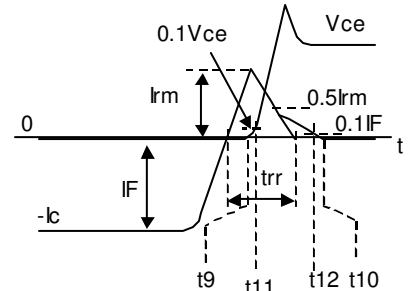

$$E_{rr}(10\%) = \int_{t_{11}}^{t_{12}} I_F \cdot V_{ce} dt$$

$$E_{rr}(Full) = \int_{t_9}^{t_{10}} I_F \cdot V_{ce} dt$$

Definition of switching loss

MBN1800E17E

7.2.3 DEPENDENCE OF CURRENT

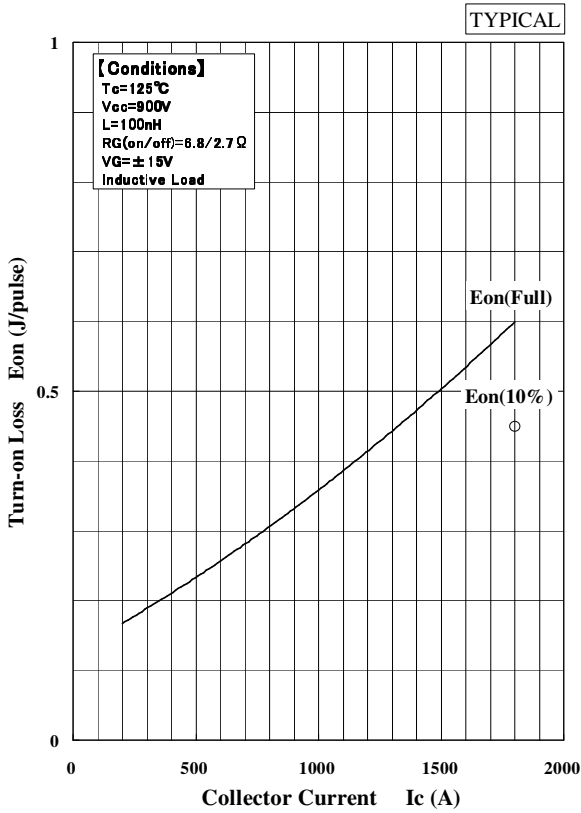

Turn-on Loss vs. Collector Current

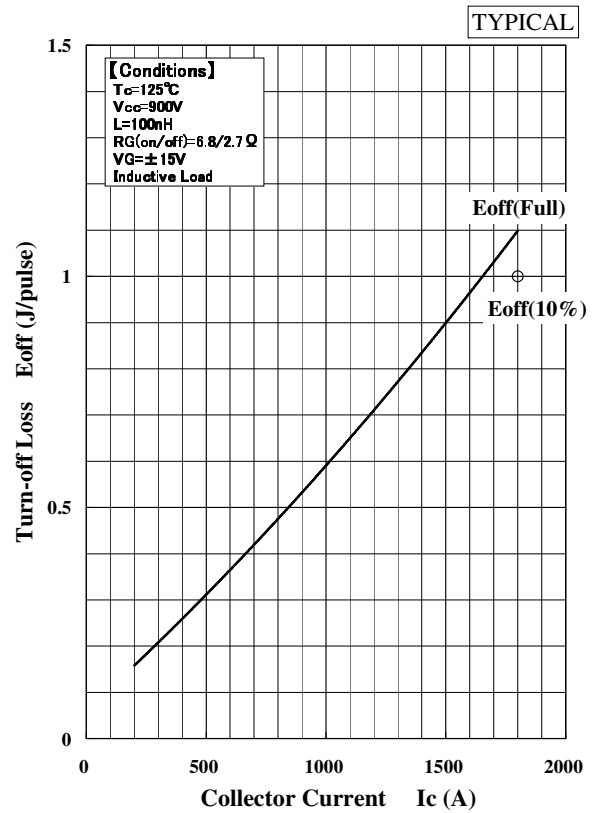

Turn-off Loss vs. Collector Current

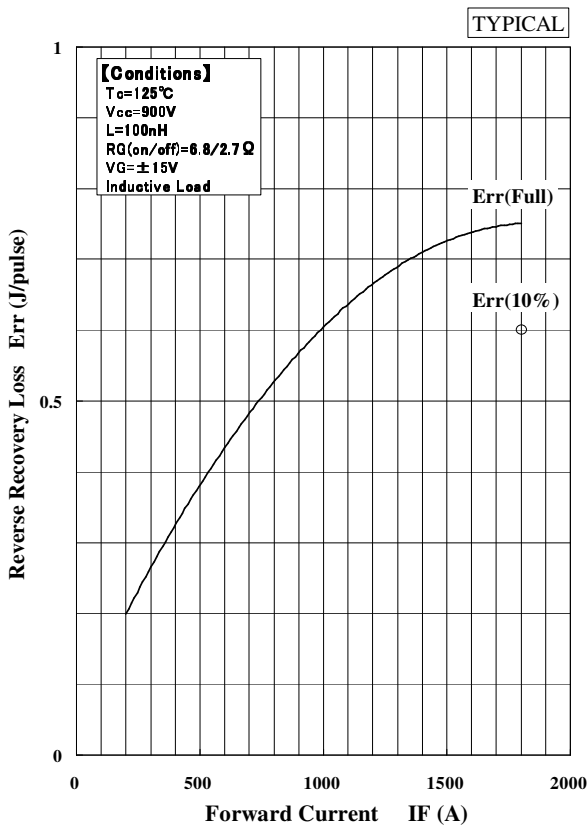

Reverse Recovery Loss vs. Forward Current

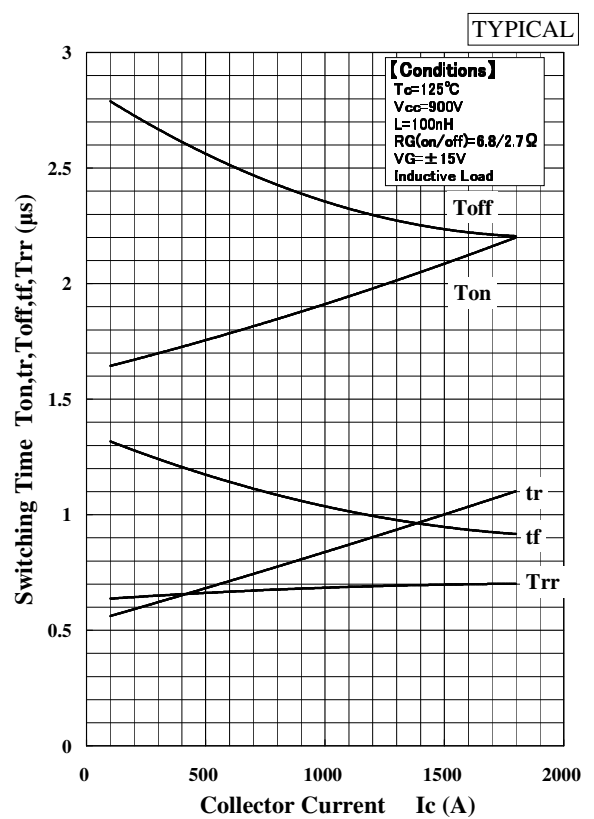

Switching Time vs. Collector Current

MBN1800E17E

7.2.4 DEPENDENCE OF RG

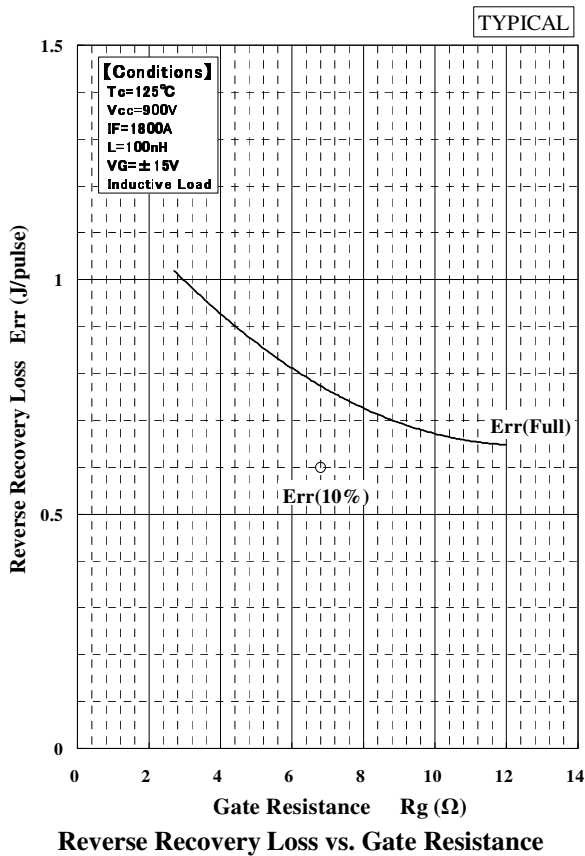
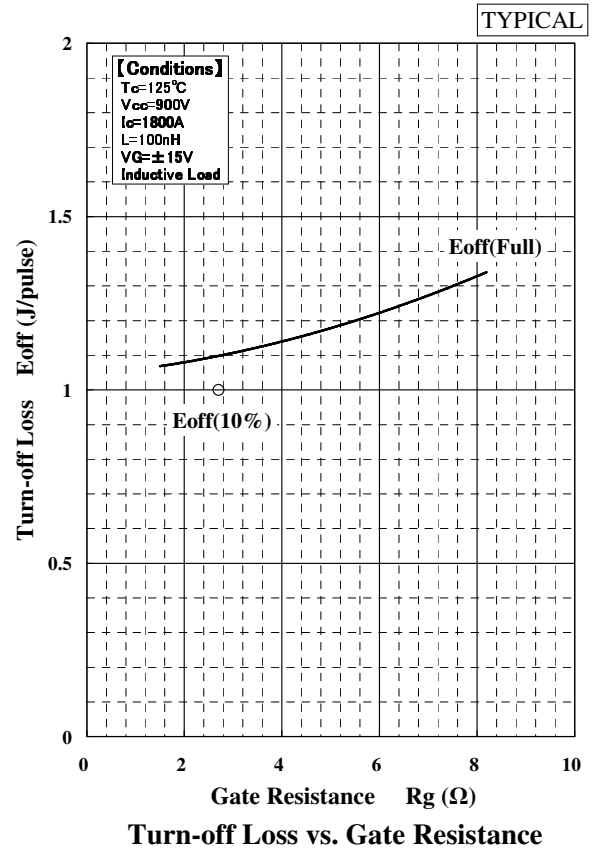
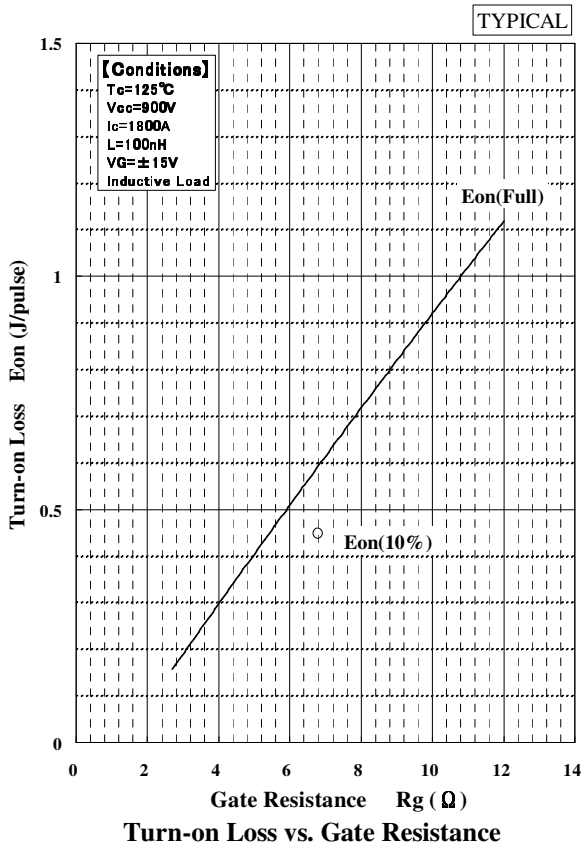

MBN1800E17E

8. PACKAGE OUTLINE DRAWING

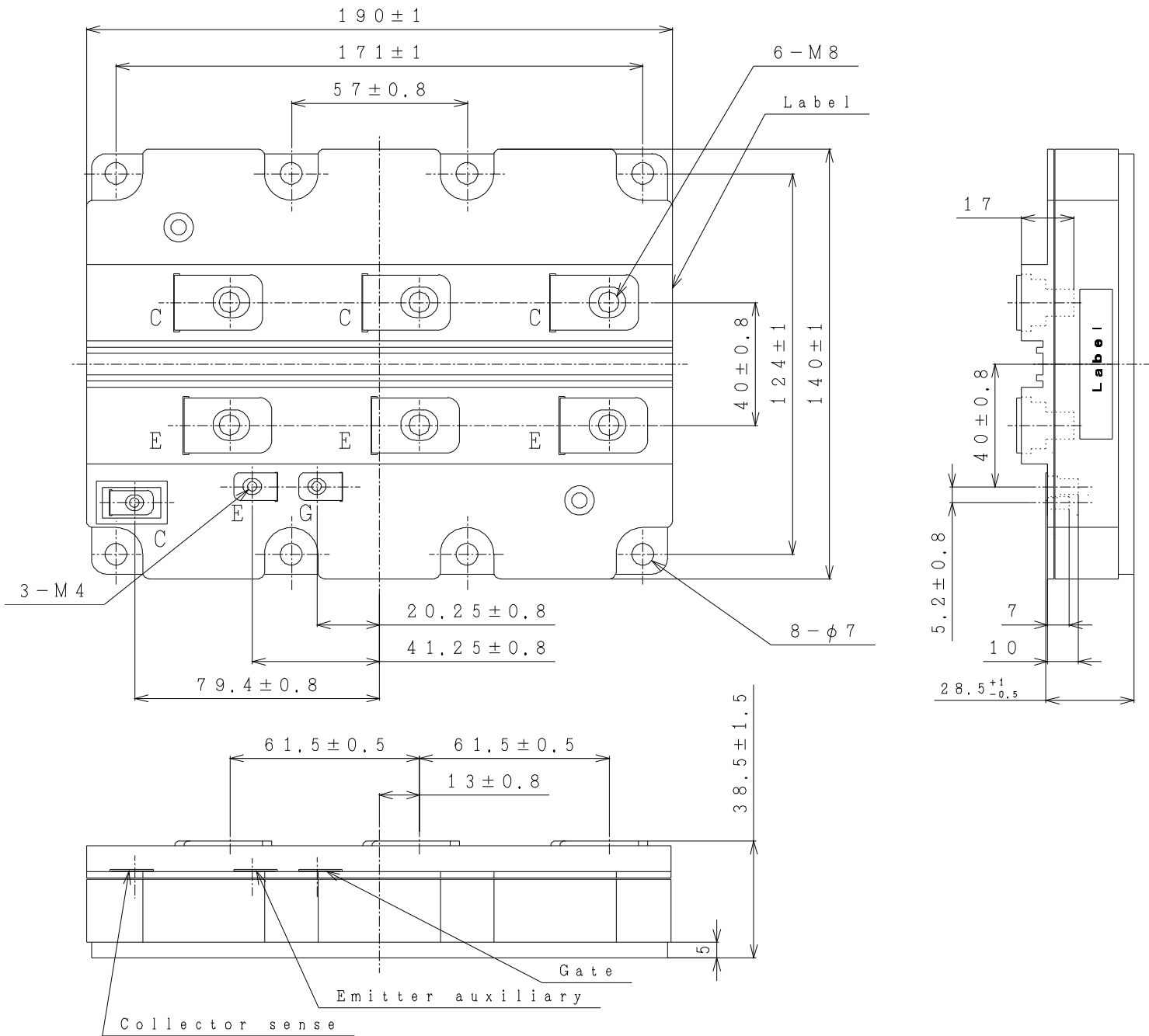

MBN1800E17E

9. Thermal Impedance

9.1 TRANSIENT THERMAL IMPEDANCE

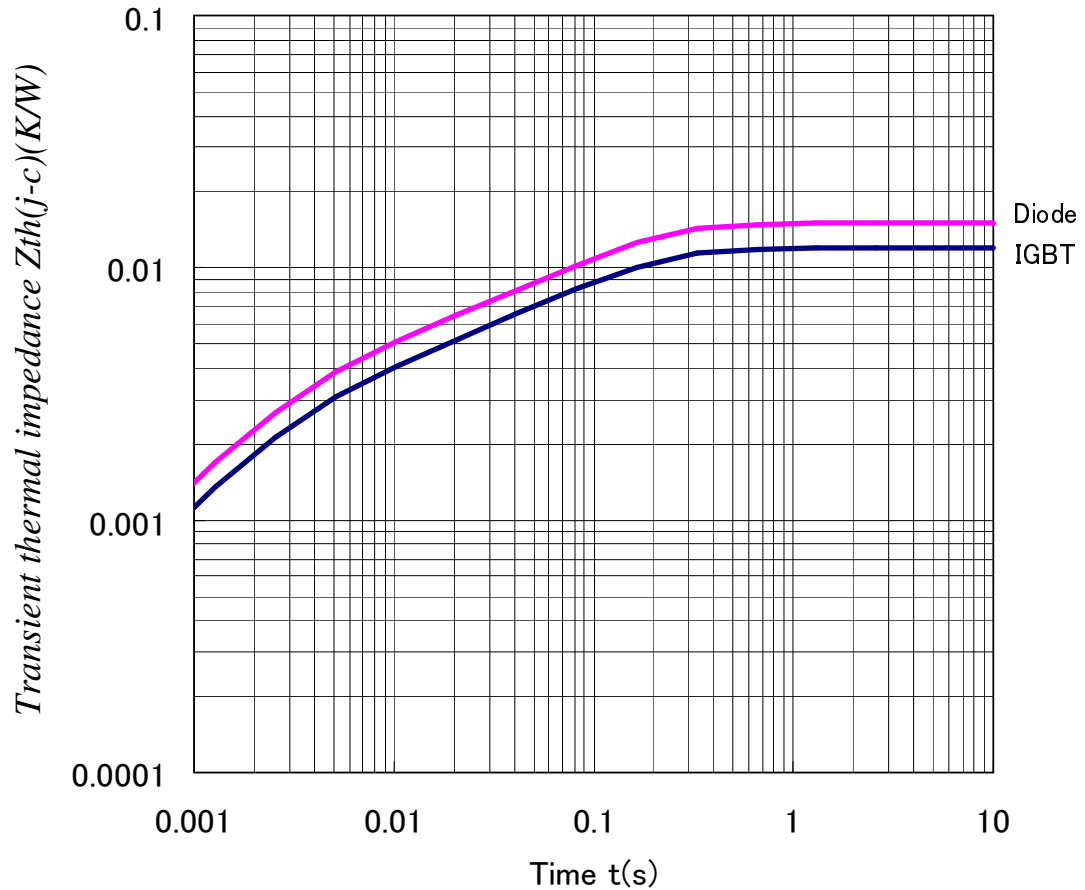

Transient Thermal Impedance Curve (Maximum Value)

10. Negative environmental impact material

Please note the following materials are contained in the product in order to keep characteristic and reliability level.

Material	Contained part
Lead (Pb) and its compounds	Solder
Arsenic and its compounds	Si chip

HITACHI POWER SEMICONDUCTORS

Notices

1. The information given herein, including the specifications and dimensions, is subject to change without prior notice to improve product characteristics. Before ordering, purchasers are advised to contact Hitachi sales department for the latest version of this data sheets.
2. Please be sure to read "Precautions for Safe Use and Notices" in the individual brochure before use.
3. In cases where extremely high reliability is required (such as use in nuclear power control, aerospace and aviation, traffic equipment, life-support-related medical equipment, fuel control equipment and various kinds of safety equipment), safety should be ensured by using semiconductor devices that feature assured safety or by means of users' fail-safe precautions or other arrangement. Or consult Hitachi's sales department staff.
4. In no event shall Hitachi be liable for any damages that may result from an accident or any other cause during operation of the user's units according to this data sheets. Hitachi assumes no responsibility for any intellectual property claims or any other problems that may result from applications of information, products or circuits described in this data sheets.
5. In no event shall Hitachi be liable for any failure in a semiconductor device or any secondary damage resulting from use at a value exceeding the absolute maximum rating.
6. No license is granted by this data sheets under any patents or other rights of any third party or Hitachi Power Semiconductor Device, Ltd.
7. This data sheets may not be reproduced or duplicated, in any form, in whole or in part, without the expressed written permission of Hitachi Power Semiconductor Device, Ltd.
8. The products (technologies) described in this data sheets are not to be provided to any party whose purpose in their application will hinder maintenance of international peace and safety not are they to be applied to that purpose by their direct purchasers or any third party. When exporting these products (technologies), the necessary procedures are to be taken in accordance with related laws and regulations.

-
- For inquiries relating to the products, please contact nearest overseas representatives that is located "Inquiry" portion on the top page of a home page.
-

Hitachi power semiconductor home page address <http://www.hitachi-power-semiconductor-device.co.jp/en/>